

## Wellendichtring Shaft seal

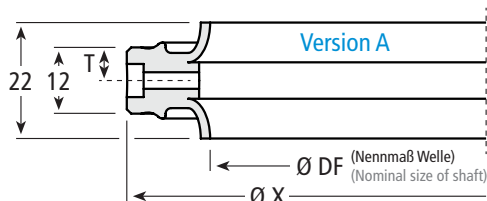

Doppellippig  
Double lipped

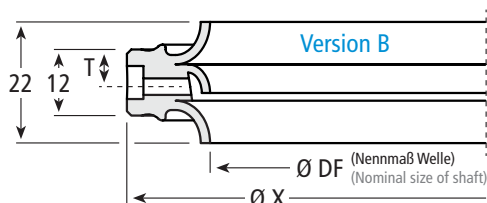

Dreilippig  
Triple lipped

## Dichtungen Gaskets

Unsere PTFE-Artikel, wie z.B. Faltenbälge, sind speziell für den Einsatz in der Lebensmittelindustrie konzipiert.

Vorteile:

- FDA-konformer Werkstoff
- Sehr gute Sterilisierbarkeit
- Universell chemikalienbeständig
- Hohe thermische Stabilität  
– 60 °C bis +200 °C
- Höchste Biegewechsel-  
festigkeit

Weitere Abmessungen  
auf Anfrage möglich.

Our PTFE items, e.g. Bellows diaphragms, are specially designed for use in the food industry.

Benefits:

- FDA conformity
- Highly suitable for sterilization
- Universal chemical resistance
- High thermal stability  
– 60 °C to +200 °C  
(– 76 °F to +392 °F)
- Highest reverse bending strength

Further dimensions  
upon request.

Artikel Nr. Part No.	Abmessungen   Dimensions in mm			Version
	Ø DF	Ø X	T	
411.0039	95	125,2	6,75	A
411.0038	100	130,2	6,75	A
411.0040	120	150,2	6	A
411.0036	140	170,2	6	A
411.0037	140	170,2	6,75	A
411.0045	150	180,2	6,75	A
411.0041	180	210,2	6	A
411.0046	210	240,2	6,75	A
411.0042	220	250,2	6	A
411.0047	95	125,2	6,75	B
411.0048	100	130,2	6,75	B
411.0049	140	170,2	6,75	B
411.0050	150	180,2	6,75	B
411.0051	180	210,2	6,75	B
411.0052	210	240,2	6,75	B

Material: PTFE compound  
Farbe | Colour: ■

## Notizen | Notes

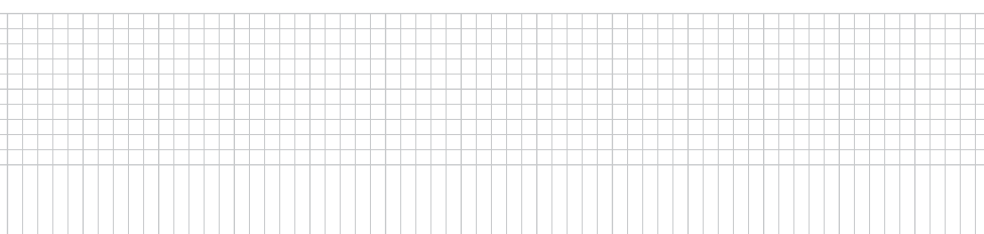

## Kolben- und Stangendichtung mit Memory-Effekt

speziell für Aspetik-Anwendungen

Piston and rod seal with memory effect  
especially for asptic applications

## Dichtungen Gaskets

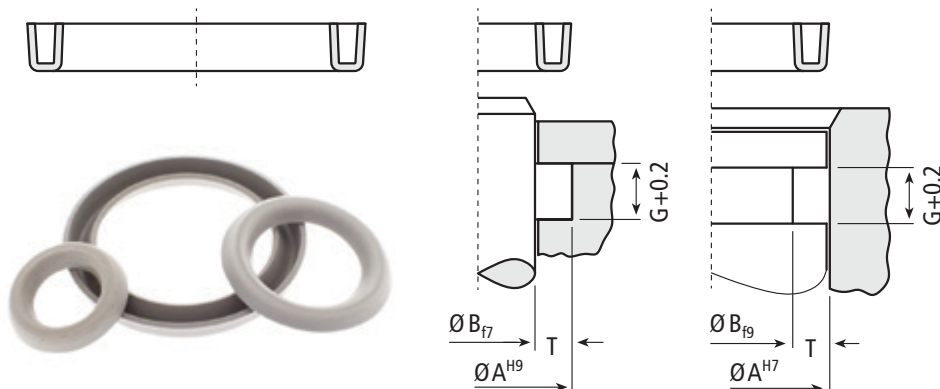

Artikel Nr. Part No.	Einbaumaße   Installation dimensions in mm			
	Bohrungs- / Zylinder-Ø Hole- / Cylinder-Ø	Stangen-Ø Rod-Ø	Nuttiefe Groove Depth	Nutbreite Groove Width
	A	B	T	G
411.0001-P	12	6	3	3,6
411.0002-P	13	7	3	3,6
411.0003-P	14	8	3	3,6
411.0004-P	16	10	3	3,6
411.0005-P	18	12	3	3,6
411.0006-P	20	14	3	3,6
411.0007-P	22	16	3	3,6
411.0008-P	24	18	3	3,6
411.0009-P	25	19	3	3,6
411.0010-P	26	20	3	3,6
411.0011-P	28	20	4	5,0
411.0012-P	30	22	4	5,0
411.0013-P	32	24	4	5,0
411.0014-P	33	25	4	5,0
411.0015-P	36	28	4	5,0
411.0016-P	38	30	4	5,0
411.0017-P	40	32	4	5,0
411.0018-P	44	36	4	5,0
411.0019-P	50	40	5	6,3
411.0020-P	55	45	5	6,3
411.0021-P	60	50	5	6,3
411.0022-P	63	53	5	6,3
411.0023-P	66	56	5	6,3
411.0024-P	70	60	5	6,3
411.0025-P	73	63	5	6,3
411.0026-P	80	70	5	6,3
411.0027-P	100	88	6	7,5

Material: PTFE compound  
Farbe | Colour: ■

Unsere PTFE-Artikel, wie z.B. Faltenbälge, sind speziell für den Einsatz in der Lebensmittelindustrie konzipiert.

Vorteile:

- FDA-konformer Werkstoff
- Sehr gute Sterilisierbarkeit
- Universell chemikalienbeständig
- Hohe thermische Stabilität  
– 60 °C bis +200 °C
- Höchste Biegewechsel-  
festigkeit

Weitere Abmessungen  
auf Anfrage möglich.

Our PTFE items, e.g. Bellows diaphragms, are specially designed for use in the food industry.

Benefits:

- FDA conformity
- Highly suitable for sterilization
- Universal chemical resistance
- High thermal stability  
– 60 °C to +200 °C  
(– 76 °F to +392 °F)
- Highest reverse bending strength

Further dimensions  
upon request.

## Topfmanschette mit einfacher oder doppelter Führung Cup packing with single or double guide

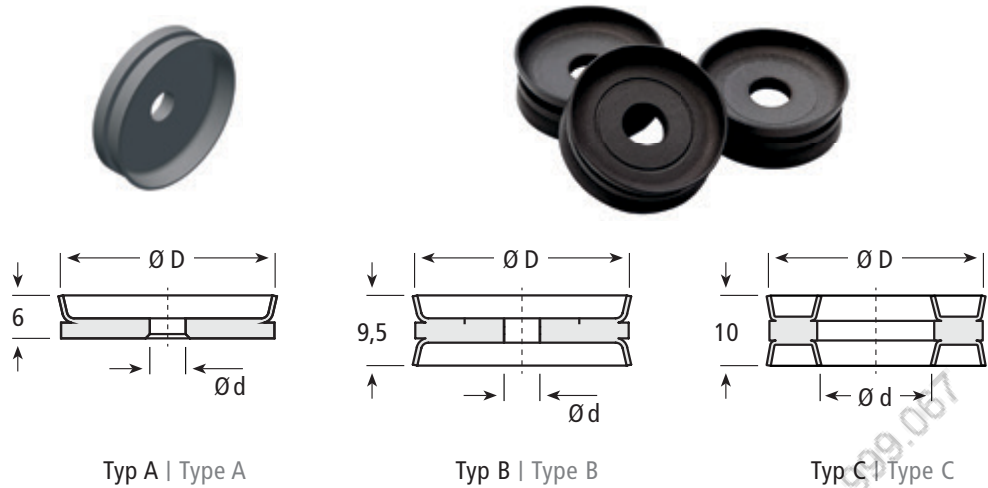

Artikel Nr. Part No.	Durchmesser   Diameter mm		Typ Type
	D	d	
106.0060	25	5	A
106.0072	25	7	A
106.0061	30	5	A
106.0073	30	7	A
106.0110	33	5	A
106.0091	25	7	B
106.0092	30	7	B
106.0115	32	16	C
Material: PTFE compound Farbe   Colour: ■			

## Ventilkegel Valve cone

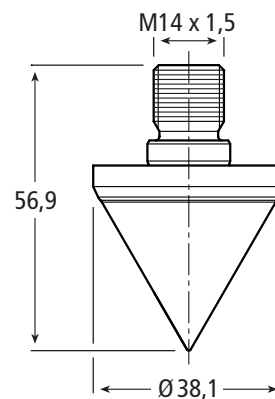

Artikel-Nr. | Part No.

**106.0066**

Material: PTFE

Farbe | Colour: □

## Kolbenmembrane Piston diaphragm

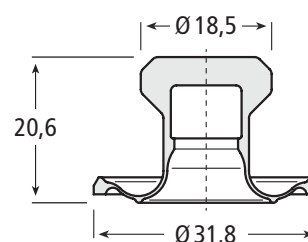

Artikel-Nr. | Part No.

**106.0335**

Material: PTFE

Farbe | Colour: □

## Dichtkegel Seal Cone

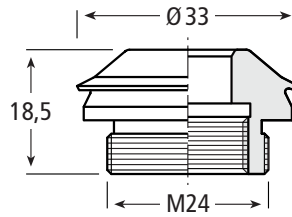

Artikel-Nr. | Part No.  
**106.0067**

Material: PTFE  
Farbe | Colour:

## Dichtkegel Seal Cone

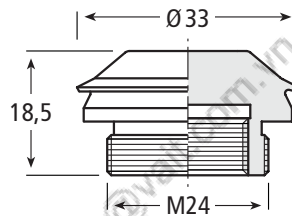

Artikel-Nr. | Part No.  
**106.0074**

Material: PTFE  
Farbe | Colour:

## Dichtkegel Seal Cone

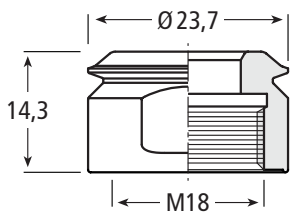

Artikel-Nr. | Part No.  
**106.0089**

Material: PTFE  
Farbe | Colour:

# Dichtungen Gaskets

Unsere PTFE-Artikel, wie z.B. Faltenbälge, sind speziell für den Einsatz in der Lebensmittelindustrie konzipiert.

Vorteile:

- FDA-konformer Werkstoff
- Sehr gute Sterilisierbarkeit
- Universell chemikalienbeständig
- Hohe thermische Stabilität  
–60 °C bis +200 °C
- Höchste Biegewechsel-  
festigkeit

Weitere Abmessungen  
auf Anfrage möglich.

Our PTFE items, e.g. Bellows diaphragms, are specially designed for use in the food industry.

Benefits:

- FDA conformity
- Highly suitable for  
sterilization
- Universal chemical  
resistance
- High thermal stability  
–60 °C to +200 °C  
(–76 °F to +392 °F)
- Highest reverse bending  
strength

Further dimensions  
upon request.

106.0060, 106.0061  
106.0072, oder / or  
106.0073

106.0299, 106.0326  
oder / or 106.0327

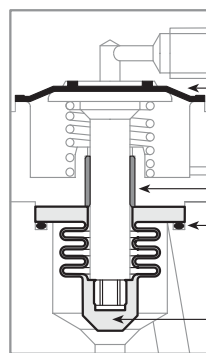
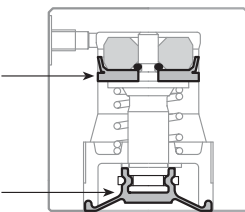

106.0279

410.0151

410.0179

106.0283

oder / or

106.0305

### Ventilfaltenbalg, 3 Falten Bellows diaphragm, 3 bellows

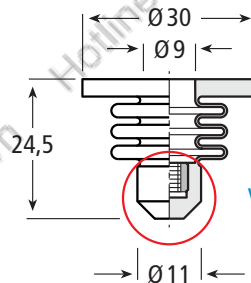

Version A

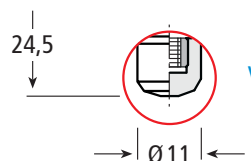

Version B

Artikel-Nr. | Part No.

**106.0283 (Version A)**

**106.0305 (Version B)**

Material: PTFE

Farbe | Colour:

### Ventilfaltenbalg, 3 Falten Bellows diaphragm, 3 bellows

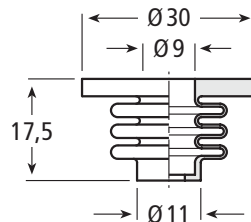

Artikel-Nr. | Part No.

**106.0323**

Material: PTFE

Farbe | Colour:

**Ventilfaltenbalg, 4 Falten**  
Bellows diaphragm, 4 bellows

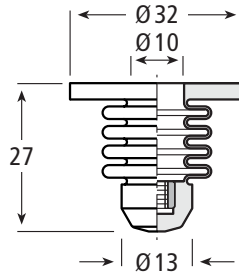

Artikel-Nr. | Part No.  
**106.0308**

Material: PTFE  
Farbe | Colour:

**Ventilfaltenbalg, 6 Falten**  
Bellows diaphragm, 6 bellows

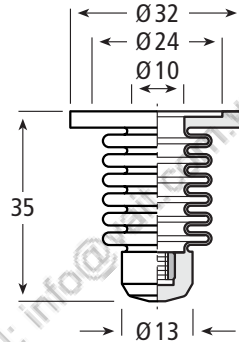

Artikel-Nr. | Part No.  
**106.0309**

Material: PTFE  
Farbe | Colour:

**Teflonbalg, 12 Falten**  
Bellows diaphragm, 12 bellows

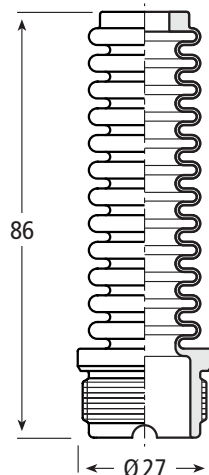

Artikel-Nr. | Part No.  
**106.0310**

Material: PTFE  
Farbe | Colour:

**Faltenbälge**  
Bellows

Unsere PTFE-Artikel, wie z.B. Faltenbälge, sind speziell für den Einsatz in der Lebensmittelindustrie konzipiert.

Vorteile:

- FDA-konformer Werkstoff
- Sehr gute Sterilisierbarkeit
- Universell chemikalienbeständig
- Hohe thermische Stabilität  
–60 °C bis +200 °C
- Höchste Biegewechselfestigkeit

Weitere Abmessungen auf Anfrage möglich.

Our PTFE items, e.g. Bellows diaphragms, are specially designed for use in the food industry.

Benefits:

- FDA conformity
- Highly suitable for sterilization
- Universal chemical resistance
- High thermal stability  
–60 °C to +200 °C  
(–76 °F to +392 °F)
- Highest reverse bending strength

Further dimensions upon request.



## Ventilfaltenbalg, 5 Falten Bellows diaphragm | 5 bellows

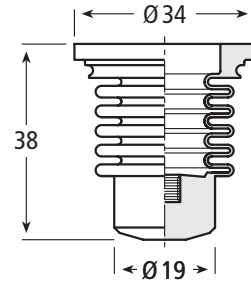

Artikel-Nr. | Part No.

**106.0360** (inkl. O-Ring | incl. O-ring)

**106.0356** (ohne O-Ring | without O-ring)

Material: PTFE

Farbe | Colour:

## Teflonbalg, 8 Falten Bellows diaphragm, 8 bellows

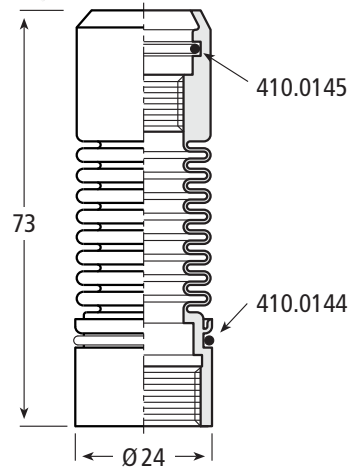

Artikel-Nr. | Part No.

**106.0321** (inkl. O-Ringe | incl. O-rings)

**106.0284** (ohne O-Ringe | without O-rings)

Material: PTFE

Farbe | Colour:

## Faltenbalg, 9 Falten Bellows diaphragm, 9 bellows

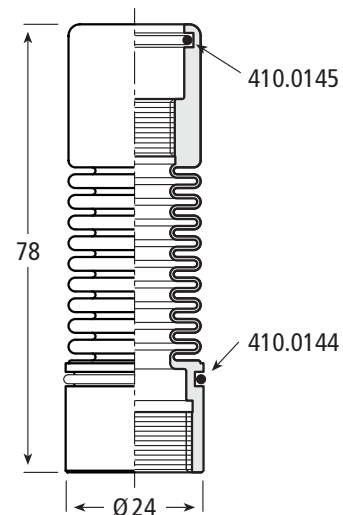

Artikel-Nr. | Part No.

**106.0322** (inkl. O-Ringe | incl. O-rings)

**106.0317** (ohne O-Ringe | without O-rings)

Material: PTFE

Farbe | Colour:

**Faltenbalg, 10 Falten**  
Bellows diaphragm, 10 bellows

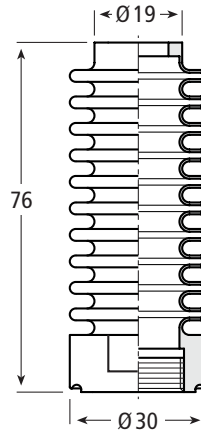

Artikel-Nr. | Part No.  
**106.0333**

Material: PTFE  
Farbe | Colour: □

**Faltenbalg, 18 Falten**  
Bellows diaphragm, 18 bellows

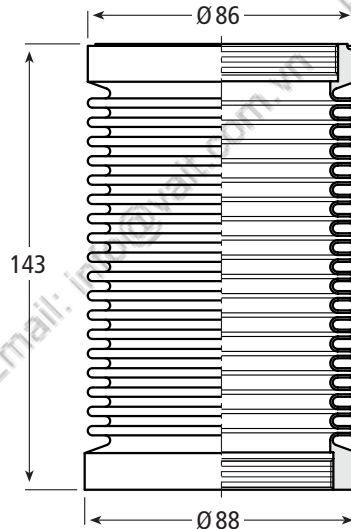

Artikel-Nr. | Part No.  
**106.0332**

Material: PTFE  
Farbe | Colour: □

**O-Ring**  
O-ring

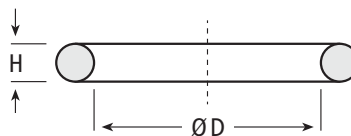

Artikel Nr. Part No.	Abmessungen   Dimensions in mm		Material	passend zu suitable to
	Ø D	H		
410.0145	16	2	EPDM	106.0284, 106.0317
410.0144	20,4	1,8	FPM	106.0284, 106.0317
410.0179	26	2	EPDM	106.0305, 106.0283
410.0197	25,4	2	EPDM	106.0360

Farbe | Colour: ■

**Faltenbälge**  
Bellows

Unsere PTFE-Artikel, wie z.B. Faltenbälge, sind speziell für den Einsatz in der Lebensmittelindustrie konzipiert.

Vorteile:

- FDA-konformer Werkstoff
- Sehr gute Sterilisierbarkeit
- Universell chemikalienbeständig
- Hohe thermische Stabilität  
– 60 °C bis +200 °C
- Höchste Biegewechsel-  
festigkeit

Weitere Abmessungen auf Anfrage möglich.

Our PTFE items, e.g. Bellows diaphragms, are specially designed for use in the food industry.

Benefits:

- FDA conformity
- Highly suitable for sterilization
- Universal chemical resistance
- High thermal stability  
– 60 °C to +200 °C  
(– 76 °F to +392 °F)
- Highest reverse bending strength

Further dimensions upon request.

**Faltenbalg, 6 Falten**  
Bellows diaphragm, 6 bellows

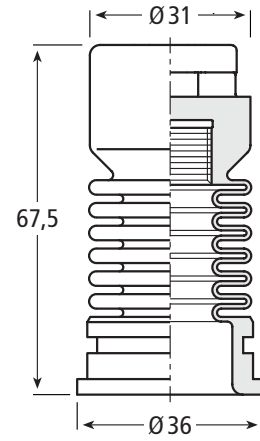

Artikel-Nr. | Part No.  
**106.0351**

Material: PTFE  
Farbe | Colour:

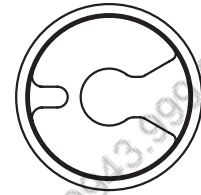

**Faltenbalg, 8 Falten**  
Bellows diaphragm  
8 bellows

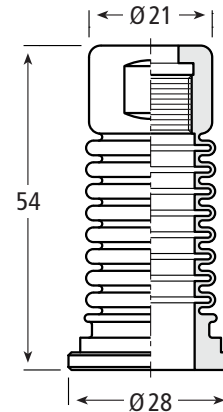
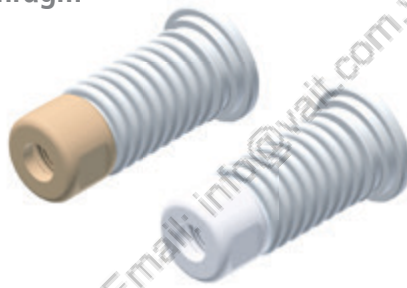

Artikel-Nr. | Part No.  
**106.0314 (PTFE & PTFE compound)**  
**106.0314-1 (PTFE)**

Material: PTFE, PTFE compound  
Farbe | Colour:

**Faltenbalg, 14 Falten**  
Bellows diaphragm, 14 bellows

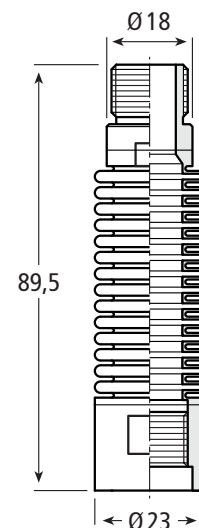
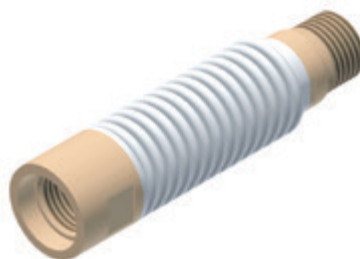

Artikel-Nr. | Part No.  
**106.0313**

Material: PTFE, PTFE compound  
Farbe | Colour:

## Faltenbalg, JO®-Alternative in PTFE

### Bellows diaphragm, JO® alternative in PTFE

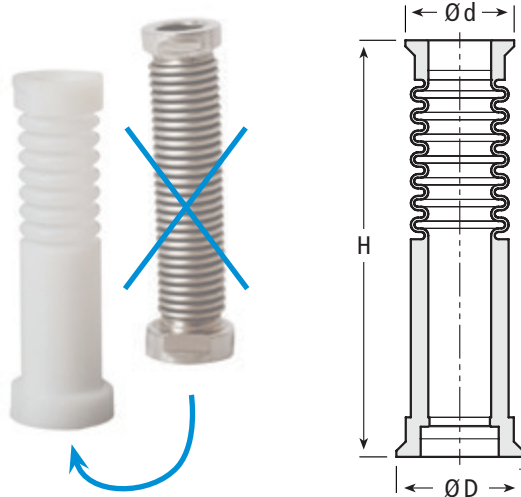

- Höhe kann abweichen - Einbaumaße/ Funktionalität identisch!
- Unsere JO®-Alternative in PTFE: exzellente Laufzeit und hervorragende chemische Beständigkeit
- Weniger Falten/Schmutzecken → bessere Hygiene
- Height can deviate - installation dimensions / functionality identical!
- Our JO® alternative in PTFE: excellent running time and outstanding chemical resistance
- Less bellows, fewer dirt corners → better hygiene

Artikel Nr. Part No.	Abmessungen Dimensions in mm			Falten Bellows
	H	Ø D	Ø d	
106.0352	69	21	18	7
106.0355	89	26	23,5	7
106.0358	82,5	26	23,5	7
106.0357	69	26	23,5	7

Material: PTFE    Farbe | Colour:

### Notizen / Notes

Grid area for notes.

**Faltenbalg, 14 Falten**  
Bellows diaphragm, 14 bellows

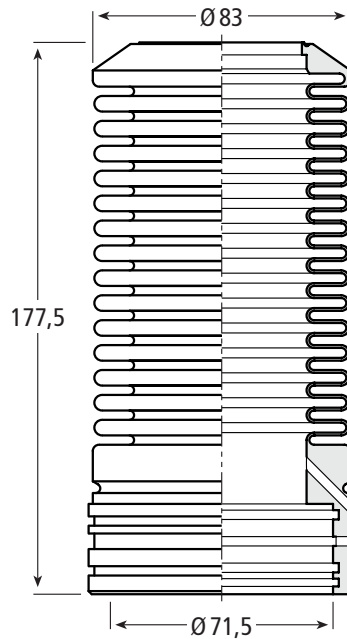

Artikel-Nr. | Part No.  
**106.0324**

Material: PTFE  
Farbe | Colour:

**Faltenbalg, 7 Falten**  
Bellows diaphragm, 7 bellows

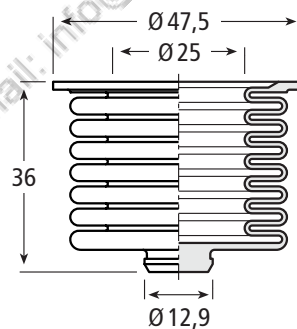

Artikel-Nr. | Part No.  
**106.0315**

Material: PTFE  
Farbe | Colour:

**Faltenbalg, 9 Falten**  
Bellows diaphragm, 9 bellows

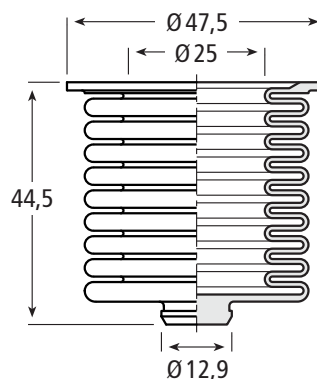

Artikel-Nr. | Part No.  
**106.0316**

Material: PTFE  
Farbe | Colour:

**Faltenbälge**  
Bellows

Unsere PTFE-Artikel, wie z.B. Faltenbälge, sind speziell für den Einsatz in der Lebensmittelindustrie konzipiert.

Vorteile:

- FDA-konformer Werkstoff
- Sehr gute Sterilisierbarkeit
- Universell chemikalienbeständig
- Hohe thermische Stabilität  
–60 °C bis +200 °C
- Höchste Biegewechsel-  
festigkeit

Weitere Abmessungen auf Anfrage möglich.

Our PTFE items, e.g. Bellows diaphragms, are specially designed for use in the food industry.

Benefits:

- FDA conformity
- Highly suitable for sterilization
- Universal chemical resistance
- High thermal stability  
–60 °C to +200 °C  
(–76 °F to +392 °F)
- Highest reverse bending strength

Further dimensions upon request.

**Faltenbalg, 7 Falten**  
Bellows diaphragm, 7 bellows

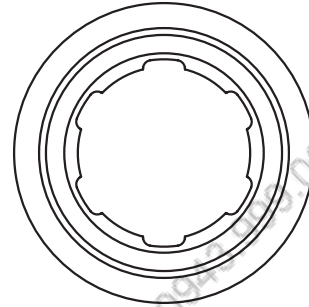
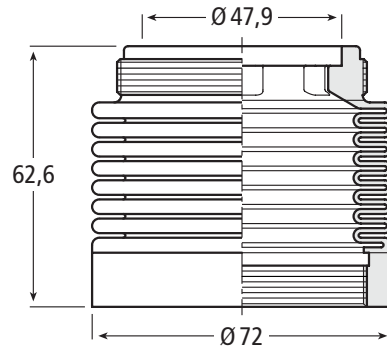

Artikel-Nr. | Part No.  
**106.0328**

Material: PTFE, PTFE compound  
Farbe | Colour:

**Faltenbalg, 6 Falten**  
Bellows diaphragm, 6 bellows

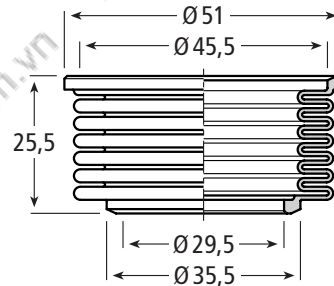

Artikel-Nr. | Part No.  
**106.0329**

Material: PTFE  
Farbe | Colour:

**Faltenbalg, 7 Falten**  
Bellows diaphragm, 7 bellows

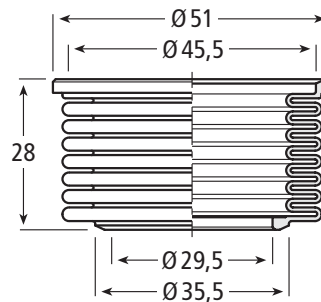

Artikel-Nr. | Part No.  
**106.0336**

Material: PTFE  
Farbe | Colour:

**Faltenbalg, 6 Falten**  
Bellows diaphragm, 6 bellows

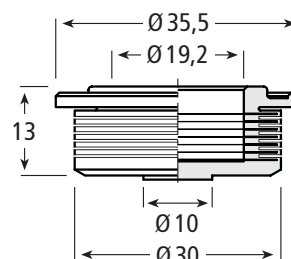

Artikel-Nr. | Part No.  
**106.0330**

Material: PTFE  
Farbe | Colour:

## Hutmanschette Cup seal

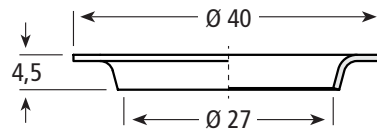

Artikel-Nr. | Part No.  
**410.0192**

Material: PTFE compound  
Farbe | Colour: ■

## Abstreifer Wiper

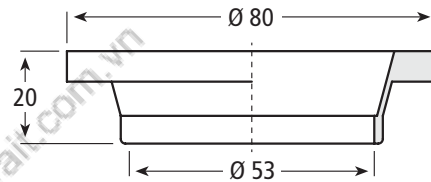

Artikel-Nr. | Part No.  
**410.0191**

Material: PTFE  
Farbe | Colour: □

## Membrane Diaphragm

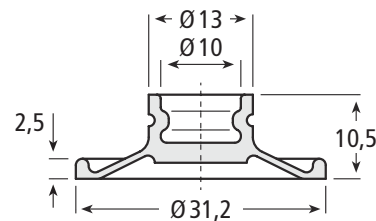

Artikel-Nr. | Part No.  
**106.0299**

Material: EPDM, gewebeverstärkt  
fabric reinforced  
Farbe | Colour: ■

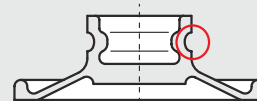

106.0299-1 derzeit nicht im Produkt-Programm  
106.0299-1 currently not in product range

## Membrane Diaphragm

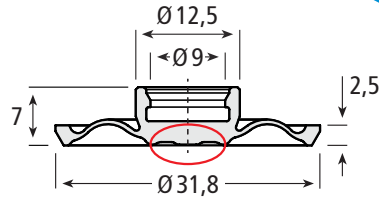

Artikel-Nr. | Part No.

**106.0326 (Version A)**

**106.0326-1 (Version B)**

Material: PTFE

Farbe | Colour:

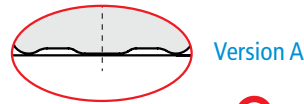

Version A



Version B

## Membrane Diaphragm

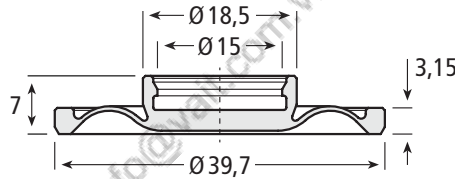

Artikel-Nr. | Part No.

**106.0327**

Material: PTFE

Farbe | Colour:

## Membrane Diaphragm

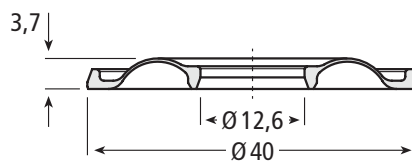

Artikel-Nr. | Part No.

**106.0331**

Material: PTFE

Farbe | Colour:

# Membranen Diaphragms

Die von uns verwendeten Polyurethan- und Kautschuk-Elastomere zeichnen sich durch herausragende Eigenschaften aus:

- Ausgezeichneter mechanischer Verschleißwiderstand
- Niedriger Druckverformungsrest
- Hohe Thermostabilität
- Elastizität und Flexibilität
- Extreme Schnittfestigkeit
- Verschiedene Härtegrade

Weitere Abmessungen auf Anfrage möglich.

Our well-chosen polyurethane and rubber elastomers offer outstanding mechanical properties:

- Excellent resistance to mechanical wear
- Low compression set
- High thermostability
- Elasticity and flexibility
- Extreme cut-resistance
- Several hardness ranges

Further dimensions upon request.



## Steuermembrane Diaphragm

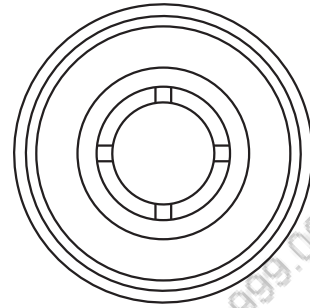
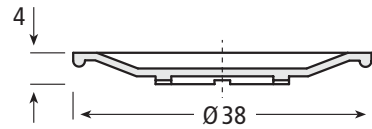

Artikel-Nr. | Part No.

**106.0279**

Material: EPDM, gewebeverstärkt | fabric reinforced

Farbe | Colour: ■

## Trennmembrane Diaphragm

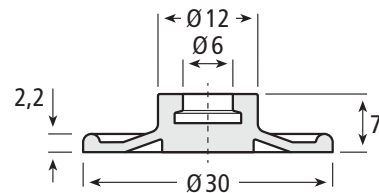

Artikel-Nr. | Part No.

**106.0243**

Material: EPDM, gewebeverstärkt | fabric reinforced

Farbe | Colour: ■

## Membrane Diaphragm

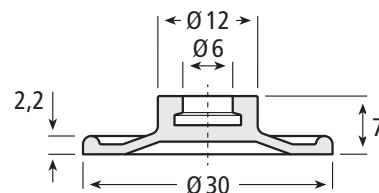

Artikel-Nr. | Part No.

**106.0282**

Material: EPDM, gewebeverstärkt | fabric reinforced

Farbe | Colour: ■